

Data Sheet



Article number: 432000220

Description: Rota-fix shaft-hub connection A 220x285
Steel

Note: Not self centering. Medium-high torques.

Measures

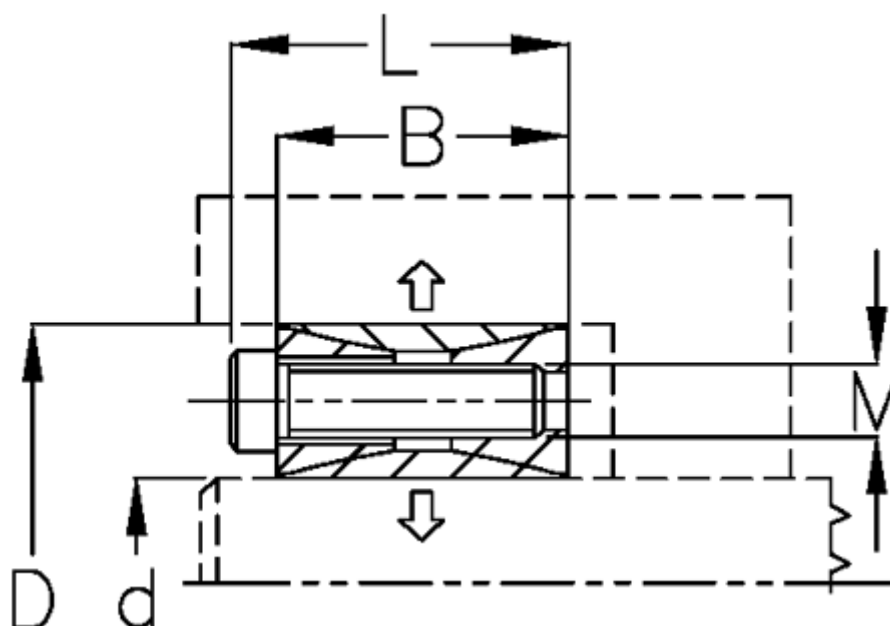

B mm	= 56
d H8 mm	= 220285
D mm	= 285
Fit tolerance	= Aksel k11-h11, Nav N11-H11
F kN torque	= 682.0
L mm	= 72
M mm	= M16
P N/mm ² surface pressure on shaft/hub	= 127

Surface roughness	=
T N m torque	=
Ts N m bolt tightening torque	=